

【Precautions】

The scale should always be used in an environment, which is free from excessive air currents, corrosives, vibration, and temperature or humidity extremes. These factors will affect displayed weight readings. Before starting the operation of the scale, please read the following instructions operate the scale properly.

DO NOT use the scale:

- next to open windows or doors causing drafts or rapid temperature changes.
- near air conditioning or heat vents.
- near vibrating, rotating or reciprocating equipment.
- near magnetic fields or equipment that generates magnetic fields.
- on a rough work surface

1. Loosen the delivery protection screw (this screw can't be removed)

Please find the delivery protection screw in the bottom of the scale. Loose it according to the instruction sticker next to it

- **Before use the scale** Loose the screw counter-clockwise to the end
- **Before move the scale** Tighten the screw clockwise to the end

2. Install the weighing pan

Put on the weighing pan to complete the installation.

3. Leveling the scale





The scale is equipped with four level adjusters. Adjust the scale to a level position with four level adjusters until the bubble appears in the center of the level indicator.

4. Recharging battery

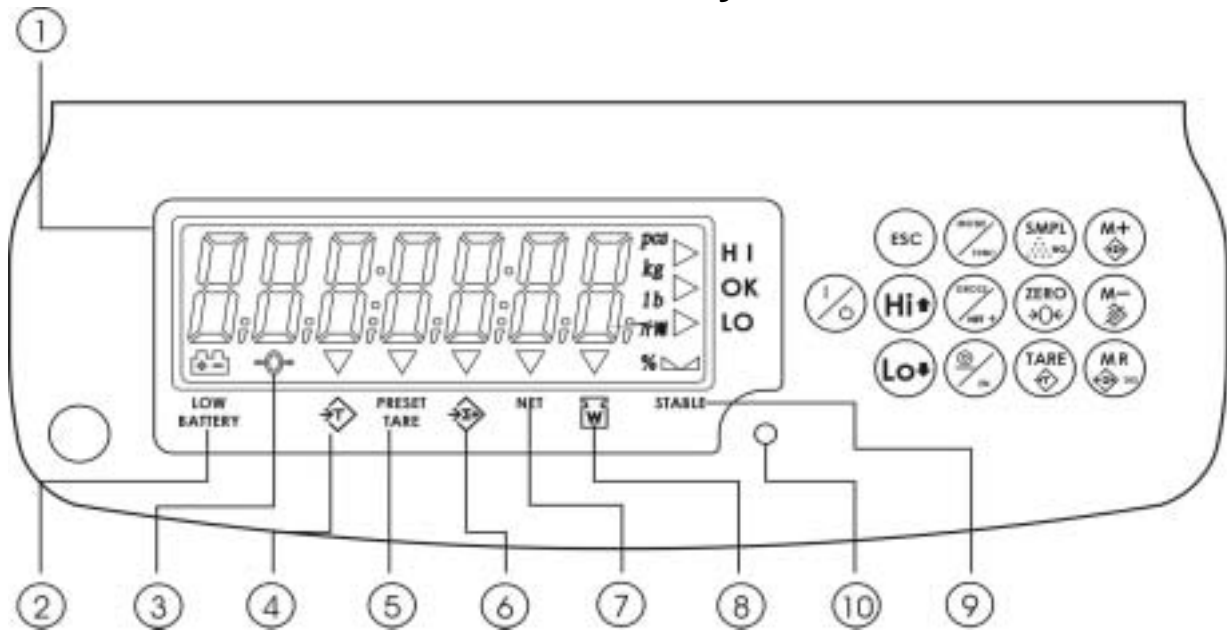
Recharging battery when the battery sign  starts blinking. When battery is being charged, the LED indicated by the word CHARGE on the display panel will be RED, the LED will become GREEN when the indicator has been charged to full capacity (charging time is about 8 hours).









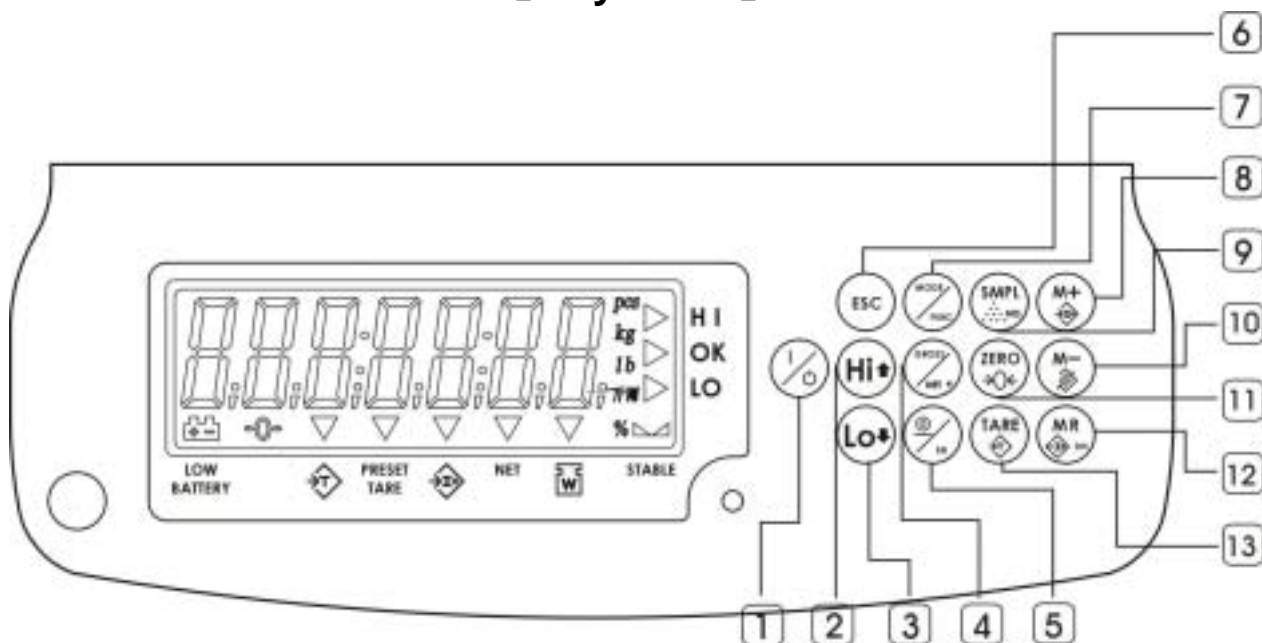



【 Function Keys 】









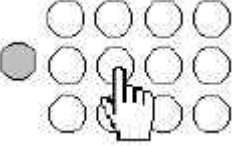

- ① : Display the value of the weight.
- ②  : Battery is low.
- ③  : The weight return to zero point.
- ④  : Tare weight value is set.
- ⑤ **PRESET TARE** : Preset the tare weight.
- ⑥  : Under accumulation.
- ⑦ **NET** : Net weight.
- ⑧  : The unit weight is lower than 4/5 e.
- ⑨ **STABLE** : The weight value is table.
- ⑩ : Red LED light is on while the battery is Charging; green LED light is on when Charging is completed.

【 Keyboard 】

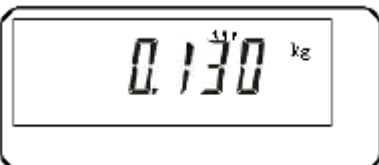



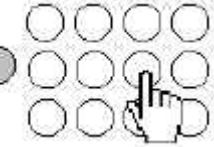

- 1**  : Power key.
- 2**  : To **select** / to set the **Hi** value of weight / To change to next content of parameter.
- 3**  : To **select** / to set the **Lo** value of weight / To change to previous content of parameter.
- 4**  : To switch Gross / Net weight / shift editing digit.
- 5**  : To print / to enable-relay output function.
- 6**  : To give up any setting and return to normal weighing mode.
- 7**  : To change unit / enter parameter setting.
- 8**  : To **Accumulate** / To next parameter.
- 9**  : To get unit weight by sampling.
- 10**  : To **delete the accumulated data** / to display year, date, time / To previous parameter.
- 11**  : Reset the weight to zero.
- 12**  : To recall accumulation data / to disable relay-output function.
- 13**  : To tare weight.

【 Change Setting Value 】



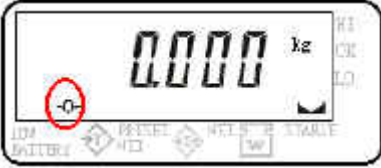
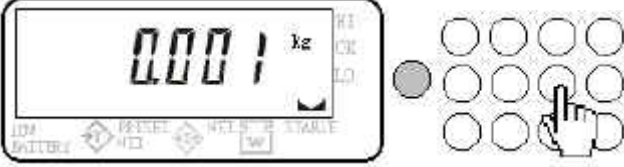







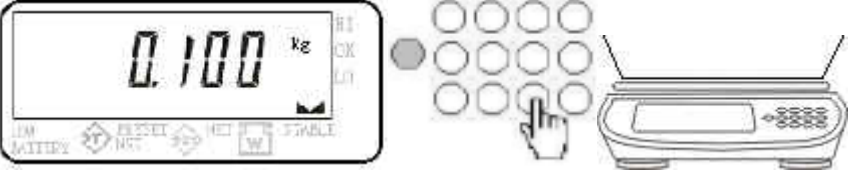

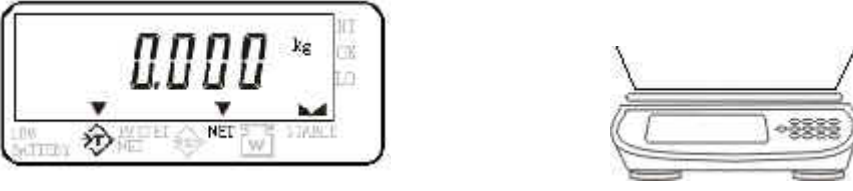
	<p>(1) When the scale enter the value setting, there is one digit blinking</p>
	<p>(2) Press  to move rightward</p>
	<p>(3) Repeat step(2) to move to the digit than you want to change.</p>
	<p>(4) Press  twice. The blinking digit become .</p> <p>(press  to increase 1.press  to decrease 1)</p>
	<p>Note: You can press  to clear the value to 0</p>

Change Setting Value be used like Set the high/lo limit, Change the serial number etc.



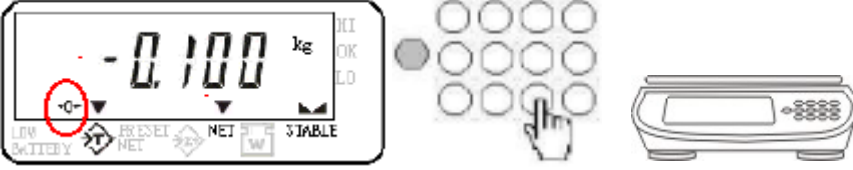





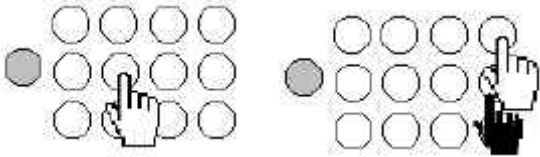

【Zero-Point】

	<p>(1) The scales zero point is shown as left diagram with $\rightarrow 0 \leftarrow$.</p>
	<p>(2) Press  key if you see the display shown as left without $\rightarrow 0 \leftarrow$, but  appears.</p>
	<p>(3) Here you see the zero point $\rightarrow 0 \leftarrow$ again.</p> <p>PS: The range of the zero point is $\pm 2\%$ of the capacity. For example, the zero range of 30K is 600g</p>



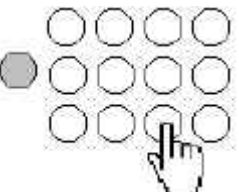







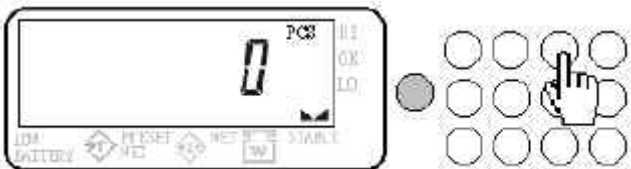

【Tare】

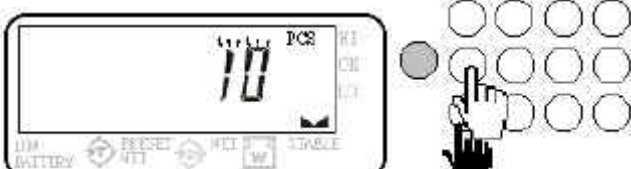
	<p>(1) Put a container weighing 0.100 kg on the pan.</p> <p>(2) Press  key when  appears.</p>
	<p>(3) TARE' symbol  appears and the arrow points to the word 'NET'. The net weight is 0.000 kg</p>
	<p>(4) Put a 3kg weight master into the container. The net weight is 3.000 kg.</p>
	<p>(5) Press  key</p>
	<p>(6) The arrow pointing to the symbol 'NET' disappears. The gross weight is 3.100 kg</p> <p>(7) Press  again and the display is showing net weight again.</p>
	<p>(8) Remove all objects from the pan. When  and  appears, press  to cancel the tare .</p>
	







【Pre- Tare】

	<p>(1) Keep pressing  3 second or so.</p>
	<p>(2) The pre-tare value will be blinking on the display.</p>
	<p>(3) Press  to move rightward</p> <p>(4) You also can press   to increase 1 or decrease 1</p>
	<p>(5) Press  key to execute the designate pre-tare.</p>
	<p>(6) The arrows point the 'NET' , 'PRESET and  in the display.</p>







【 PCS / % Counting 】

	<p>(1) Press and release  until unit change to PCS(or %) mode as following</p>
	<p>(2) Press , then the selectable PCS will be blinking as following</p>
	<p>(3) Press  or  to select 10,25,50, 100PCS</p>
	<p>(4) Press  after getting the selected PCS</p>
	<p>(5) It can start to count PCS after the blinking vanish..</p>
<p>Note1: If your scale only have either PCS or %, you can skip step(1) to directly press  to Select related PCS or % in any unit mode.</p> <p>Note2: This sampling base can be used for next time if the scale turn off on proper way. (don't plug out the power cable to turn off the scale, it's improper way. Please press  to turn off the scale)</p>	

【 Manual Accumulation 】











	<p>(1) Put object on the pan</p>
	<p>(2) Wait for the ▼ symbol to appear. Then press </p>
	<p>(3) <i>ACC</i> will be blinking while accumulating.</p>
	<p>(4) After the blinking vanish, the ▼ above  will be on.</p>
	<p>(5) Remove all objects from the pan. Start from step(1) to do another accumulation.</p>
<p>PS: When the weight is less than 20e, it will go into accumulation setting mode. For example: model 30kg x1g,. 20e=20g</p>	

【 Manual Print 】

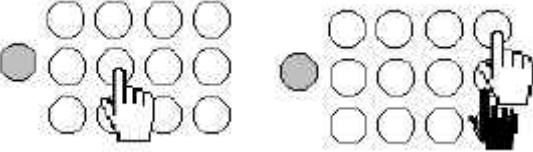



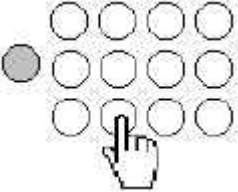









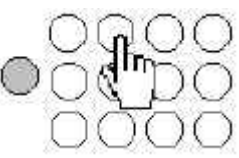

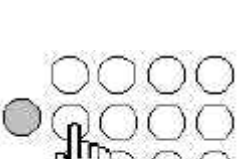
	<p>(1) Put object on the pan</p>
	<p>(2) Wait for the  symbol to appear. Then press </p>
	<p>(3) The value is blinking while sending.</p>
	
<p>PS: When the weight is less than 20e, it will go into print setting mode. For example: model 30kg x1g,. 20e=20g</p>	

【Set / Choose A Print Form】

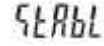



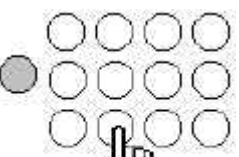





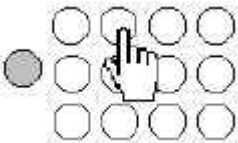

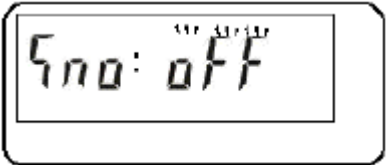
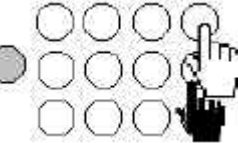
EZ-2P/BP-443D set 0~99 forms; SH-24 set 0~8 forms

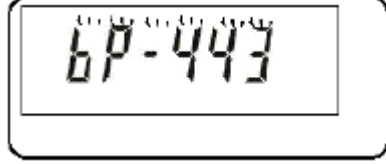
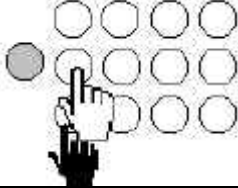
	<p>(1) Under normal weighing mode press  when the pan is empty. (If there is object on the pan and you press  then it will print out)</p>
	<p>(2)  is blinking to indicate to change.</p>
	<p>(3) Press  to move rightward</p> <p>(4) You also can press   to increase 1 or decrease 1</p>
	<p>(5) For example if you wish to print the 9th form,</p>
	<p>(6) Press  key to complete the setting and return to normal weighing mode.</p>
	<p>(7) Return to normal weighing mode.</p>



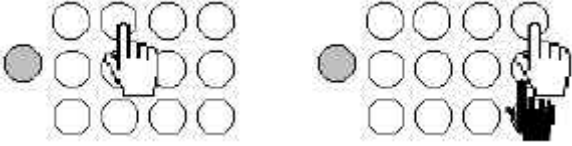







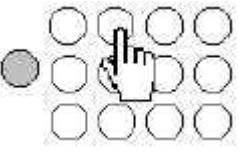

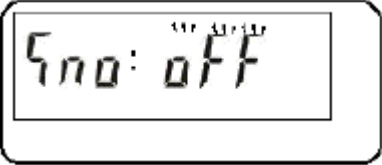
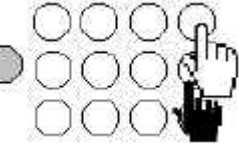

【Set Printing Mode】

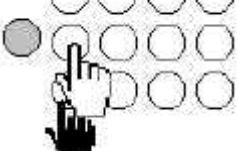
	<p>(1) Under normal weighing mode press  when the pan is empty. (If there is object on the pan and you press  then it will print out)</p>
	<p>(2) Now it's in print form setting.</p>
	<p>(3) Press  to change to printing mode setting</p>
	<p>(4) The printing mode is now blinking.</p>
	<p>(5) Press  or  to select that mode you want.</p> <ul style="list-style-type: none">  Print out by manual  Print out when stable  Print out when OK  Always sent out  No print out
	<p>(6) Press  to finish the setting</p>



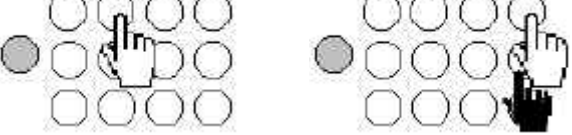







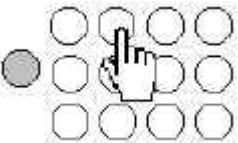

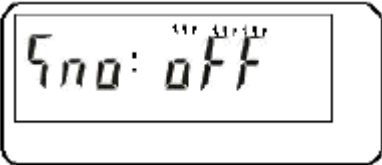
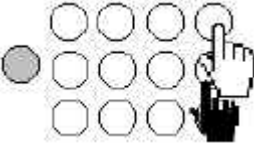

【 Select The Printer Model 】

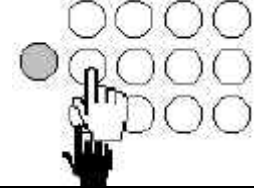
	<p>(1) Under normal weighing mode keep pressing  for about three seconds.</p>
	<p>(2) You will enter into parameter settings.</p>
	<p>(3) Press  or  to switch between the parameters.</p>
	<p>(4) Repeat step (3) until appears like one of the following. (<i>normal</i>, <i>5H-24</i>, <i>E2-2P</i>, <i>6P-443</i>)</p>
	<p>(5) Press  or  to choose printer model.</p>
	<p>(6) For example, you select <i>normal</i></p>
	<p>(7) Press  to save the setting and return to normal weighing mode.</p> <p>Note: you also can press  or  to save and go to next parameter setting.</p>

【 Set RS-232 Baud Rate 】

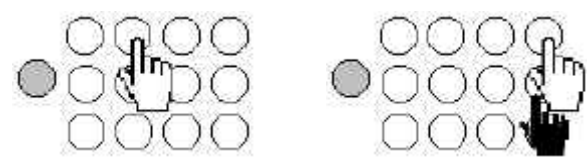
	<p>(1) Under normal weighing mode keep pressing  for about three seconds.</p>
	<p>(2) You will enter into parameter settings.</p>
	<p>(3) Press  or  to switch between the parameters.</p>
	<p>(4) Repeat step (3) until appears like one of the following. (19200, 9600, 4800, 2400)</p>
	<p>(5) Press  or  to choose baud rate.</p>
	<p>(6) For example, you select <i>9600</i></p>
	<p>(7) Press  to save the setting and return to normal weighing mode.</p> <p>Note: you also can press  or  to save and go to next parameter setting.</p>

【RS-232 Data Format】

	<p>(1) Under normal weighing mode keep pressing  for about three seconds.</p>
	<p>(2) You will enter into parameter settings.</p>
	<p>(3) Press  or  to switch between the parameters.</p>
	<p>(4) Repeat step (3) until appears like one of the following. (<i>E81, o81, n81, E71, o71, n71</i>)</p>
	<p>(5) Press  or  to choose the data format.</p>
	<p>(6) For example, you select <i>n81</i></p>
	<p>(7) Press  to save the setting and return to normal weighing mode.</p> <p>Note: you also can press  or  to save and go to next parameter setting.</p>

【 Samples Of BP-443D/ EZ-2P Printing Formats 】

10 printing formats is preset by manufacturer

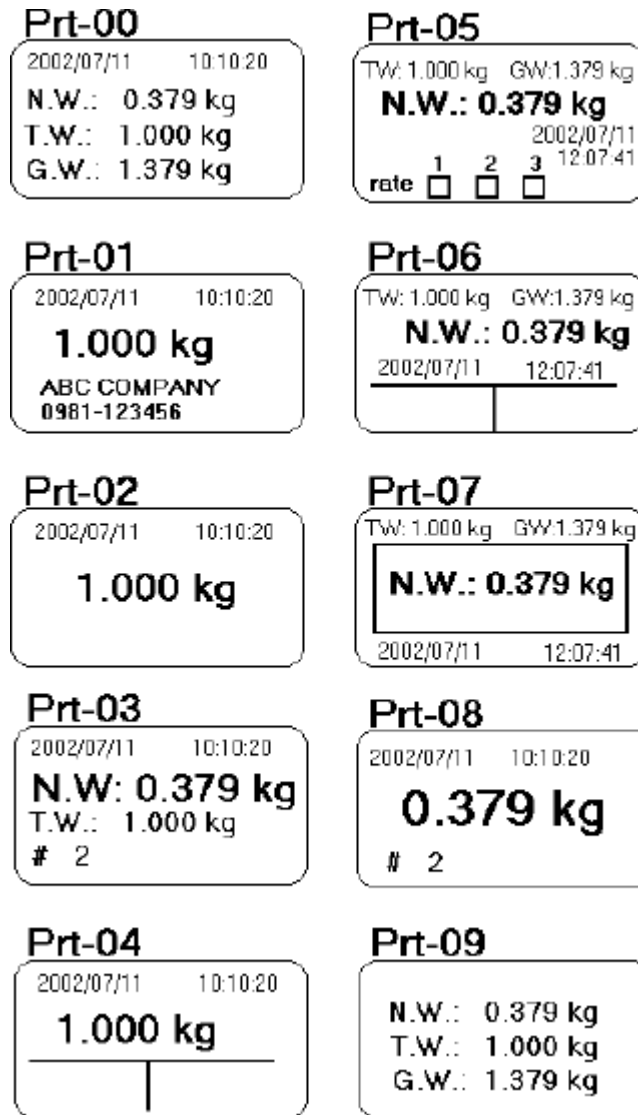

Note :

- (1) Please contact your supplier/-dealer for additional EZ-2P & BP-443D printing formats.
- (2) A memory card has to be installed in EZ-2P. (BP-443D memory card is standard)
- (3) A RTC-device has to be installed in EZ-2P if you need to print time/-date. (BP-443D RTC is standard)
- (4) The printing formats are installed into the printers through PC. Please email us and we will make the requested printing formats for you.

【 Sample Of SH-24 Printing Formats 】8 forms

Prt-00	0.379kg
Prt-01	2002/01/01 00:09:23 0.379kg
Prt-02	#1 0.379kg
Prt-03	2002/01/01 00:09:23 #1 0.379kg
Prt-04	N.W: 0.379 kg T.W: 0.100 kg G.W: 0.479 kg
Prt-05	2002/01/01 00:09:23 N.W: 0.379 kg T.W: 0.100 kg G.W: 0.479 kg
Prt-06	#1 N.W: 0.379 kg T.W: 0.100 kg G.W: 0.479 kg
Prt-07	2002/01/01 00:09:23 #1 N.W: 0.379 kg T.W: 0.100 kg G.W: 0.479 kg

When **ALLO3** appear under Display of accumulation, press .the printout will be two types

. when there're objects on platform, the printout will include each individual data like as following

```

2002/01/01 00:09:23
(1) 0.100 kg
(2) 0.100 kg
(3) 0.100 kg
-----
0.300 kg
    
```

when there're no objects on platform, the printout will only have the total value as following











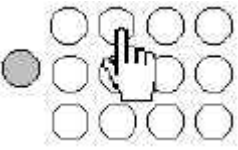

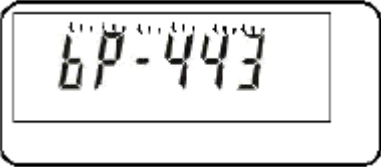
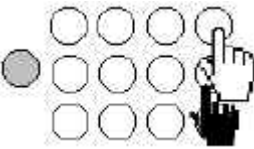
```

2002/01/01 00:09:23
0.300 kg
    
```

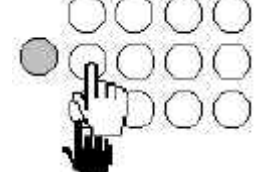

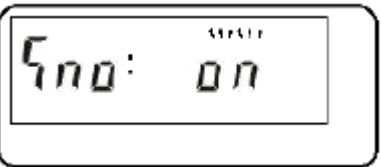
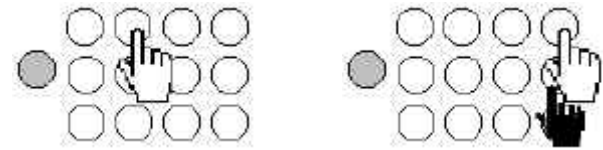





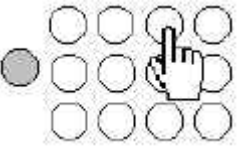

Note :

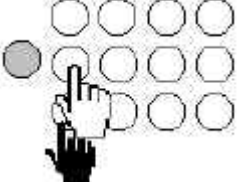
- (1) If you wish the SH-24 should be able to print date & time, the scale needs an optional module RS-232+RTC.
- (2) If you have a printer which is compatible with the SH-24, then just connect it to the scale and choose print model **normal** (even it is not the SH-24). Please choose own of the print formats from Prt-00 to Prt-08 and if the print appears correct, means that the printer is compatible with the SH-24.





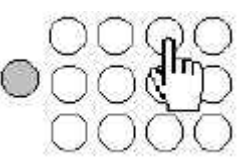

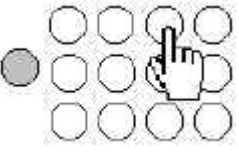

【 Activate The Serial Number Function 】

	<p>(1) Under normal weighing mode keep pressing  for about three seconds.</p>
	<p>(2) You will enter into parameter settings.</p>
	<p>(3) Press  or  to switch between the parameters.</p>
	<p>(4) Repeat step (3) until 'Sno' appear</p>
	<p>(5) Press  or  to turn on the serial Number as following display</p>
	
	<p>(6) Press  to save the setting and return to normal weighing mode.</p> <p>Note: you also can press  or  to save and go to next parameter setting.</p>

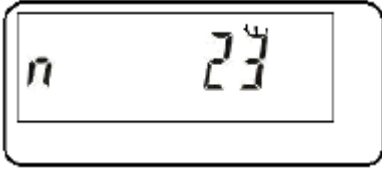
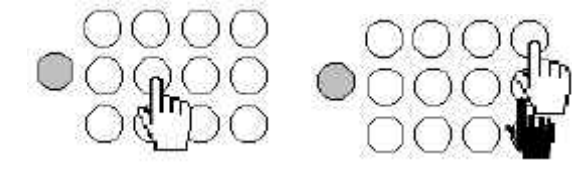
【Set The Serial Number Mode】



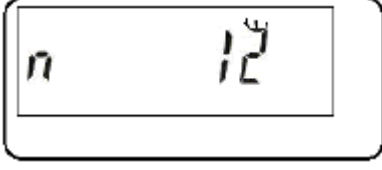
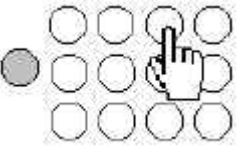





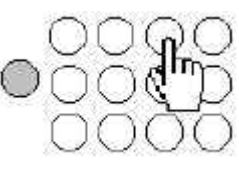

	<p>(1) Press  to enter the serial number mode when there's no object on the pan.</p>
	<p>(2) The serial number mode is blinking on the display</p>
	<p>(3) Press  or  to choose serial number mode</p> <p> No action.</p> <p> The serial no. plus 1 when  sign appear.</p> <p> The serial no. plus 1 when value is between HI – LO limits.</p>
	<p>(4) Press  to save setting and return to normal weighing mode.</p>

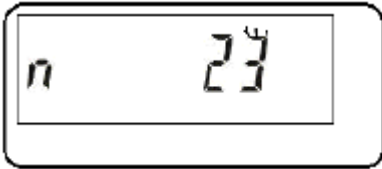
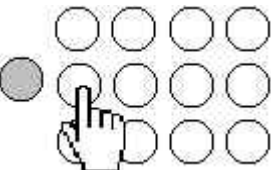
【 Change The Serial Number 】

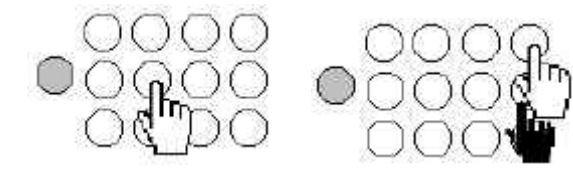



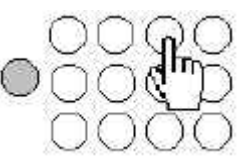





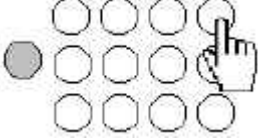

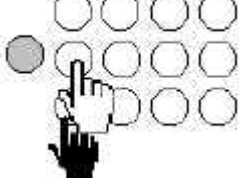
	<p>(1) When there's no object on the pan, keep press  for 3 second around until the following display appear</p>
	<p>(2) Now, the current serial number is blinking</p>
	<p>(3) Press  to move rightward</p> <p>(4) You also can press   to increase 1 or decrease 1</p>
	<p>(5) For example, the serial number is changed to 12</p>
	<p>(6) Press  to save the change and return to normal weighing mode.</p>

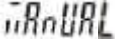
【 Set Max. Serial Number 】limit 99999

The max. serial number is up to 99999, you can change the max. serial number as shown below.

	<p>(1) When there's no object on the pan, keep press  for 3 second around until the following display appear</p>
	<p>(2) Now, the current serial number is blinking</p>
	<p>(3) Press  to enter the max. serial number setting, and will show as following</p>
	
	<p>(4) Press  to move rightward</p> <p>(5) You also can press   to increase 1 or decrease 1</p>
	<p>(6) For example, the max. serial number is changed to 120</p>
	<p>(7) Press  to save the change and return to normal weighing mode.</p>

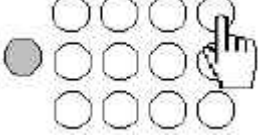





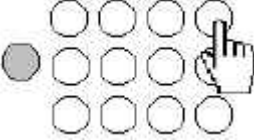

【Set / Choose Accumulation Mode】

	<p>(1) Under normal weighing mode and when the pan is empty then press  (If there is a object on the pan, it will accumulate.)</p>
	<p>(2) The accumulation mode is now blinking.</p>
	<p>(3) Press  or  to choose accumulation mode</p> <p> Accumulate by pressing </p> <p> Accumulate when  sign appear.</p> <p> Accumulate when value is between HI – LO limits.</p>
	<p>(4) For example, you want to change to stable mode.</p>
	<p>(5) Press  to save the settings and return to normal weighing mode.</p>

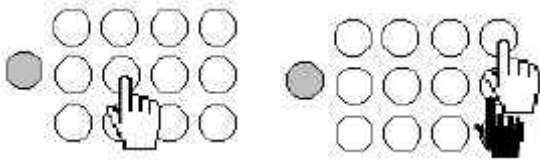



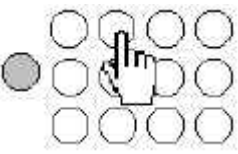

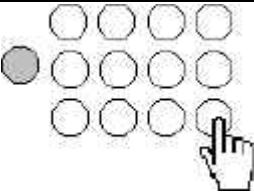

【Set The Max. Amount Of Accumulations】 the limit is 50

The max. accumulation number is up to 99, you can change the max. accumulation number

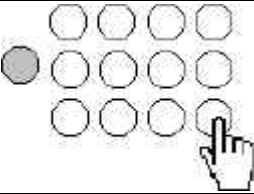

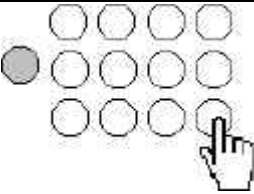

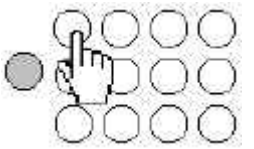

as shown below.

	<p>(1) Under normal weighing mode and when the pan is empty then keep pressing  for 3 second until the following display appears</p>
	<p>(2) The max. amount is now blinking.</p>
	<p>(3) Press  to move rightward (4) You also can press   to increase 1 or decrease 1</p>
	<p>(5) For example, you change the max amount to 12</p>
	<p>(6) Press  to save the change and return to normal weighing mode.</p>

【 Display Of Accumulation 】

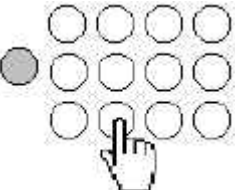

	<p>(1) Under normal weighing mode press  (assume that you have accumulated 10 times)</p>
	<p>(2) The display will show the left two displays in circulation. <i>ACC - 10</i> means the 10th data.</p>
	<p>(3) Press , Then the display will show as followings</p>
	<p>(4) The display will show the left two displays in circulation. <i>ALL - 10</i> means there are 10 amount of accumulation.</p>
	<p>(5) Press  to will show 1st weight (6) Press  again to show 2nd, 3rd.....</p>
	<p>(7) If you don't want to delete, press  and return to the normal weighing mode.</p>

【Print While Display Of Accumulation】only for SH-24





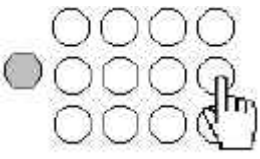

<p>Print one set of accumulation</p> <p>Enter display of accumulation, when it show single set press </p>			
 	<p>(1) It's now showing the 10th data</p>		
	<p>(2) Press  to print out as following</p> <p style="text-align: center;">2002/01/01 00:09:23 (1) 0.100 kg</p>		
<p>Print total accumulation</p> <p>Enter display of accumulation, when it show total, press </p>			
 	<table border="0" style="width: 100%;"> <tr> <td style="width: 50%; vertical-align: top;"> <p>Weight on the scale will Print out as following.</p> <p style="text-align: center;">2002/01/01 00:09:23 (1) 0.100 kg (2) 0.100 kg (3) 0.100 kg ----- 0.300 kg</p> </td> <td style="width: 50%; vertical-align: top;"> <p>No weight on the scale Will print out as following.</p> <p style="text-align: center;">2002/01/01 00:09:23 0.300 kg</p> </td> </tr> </table>	<p>Weight on the scale will Print out as following.</p> <p style="text-align: center;">2002/01/01 00:09:23 (1) 0.100 kg (2) 0.100 kg (3) 0.100 kg ----- 0.300 kg</p>	<p>No weight on the scale Will print out as following.</p> <p style="text-align: center;">2002/01/01 00:09:23 0.300 kg</p>
<p>Weight on the scale will Print out as following.</p> <p style="text-align: center;">2002/01/01 00:09:23 (1) 0.100 kg (2) 0.100 kg (3) 0.100 kg ----- 0.300 kg</p>	<p>No weight on the scale Will print out as following.</p> <p style="text-align: center;">2002/01/01 00:09:23 0.300 kg</p>		

【 Delete Accumulations 】

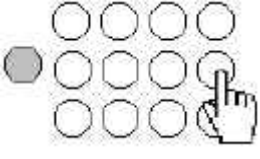

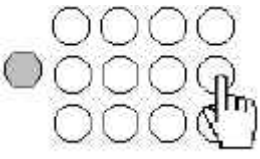

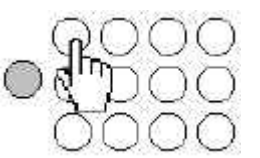



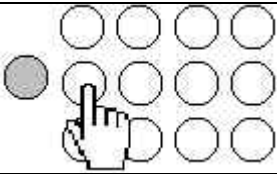

Delete one single accumulation

	<p>(1) Enter the Display of accumulation and to that data you're going to delete</p>
	<p>(2) Press  to delete 10th data.</p>

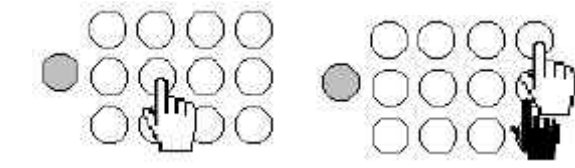



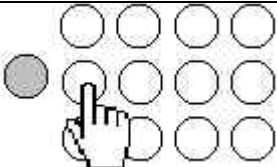



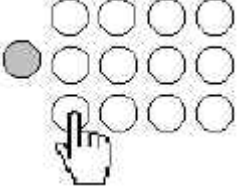

Delete all accumulation

	<p>(1) To delete all accumulation it is important to have all accumulation appearing in the display like as left</p>
	<p>(2) Press , then it'll show as following</p>
	<p>(3) The left display means "delete-All?"</p>
	<p>(4) Press  to delete all accumulation and return to normal mode. (if you don't want to delete, just skip this step, and do step(5) directly.</p>
	<p>(5) If you don't want to delete, press  and return to the normal weighing mode.</p>

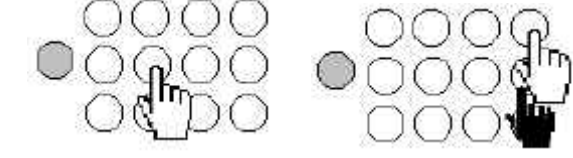



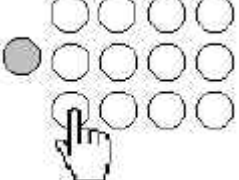

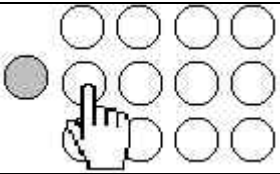

【Set The High Limit Of Measuring Value】

	<p>(1) Under normal mode press the  key</p>
	<p>(2) The display now is showing the high limit</p> <p>PS: ▶ point to Hi (without  showing)</p>
	<p>(3) Press  to move rightward</p> <p>(4) You also can press  to plus 1 or  to minus 1</p>
	<p>(5) For example, you change to 0.249 kg</p>
	<p>(5) Press  key again and the setting 0.249 kg is completed</p>

【Set The Low Limit Of The Weight】

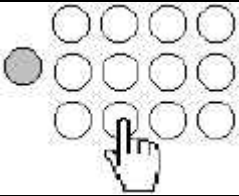

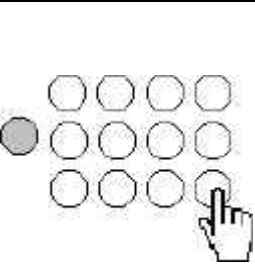





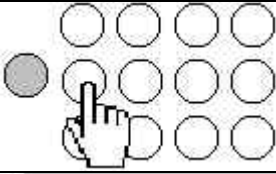

	<p>(1) Under normal weighing mode press  key</p>
	<p>(2) The display now is showing the low limit</p> <p>PS: ▶ point to Lo (without  showing)</p>
	<p>(3) Press  to move rightward</p> <p>(4) You also can press  to plus 1 or  to minus 1</p>
	<p>(5) For example, you change to 0.240 kg</p>
	<p>(6) Press  key again and the setting 0.240 kg is completed.</p>

【 Enable / Disable The Hi/Lo Checking Function 】

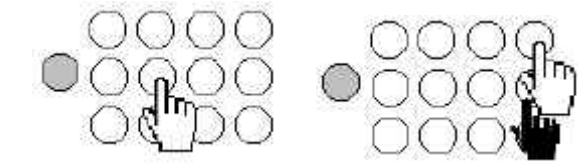



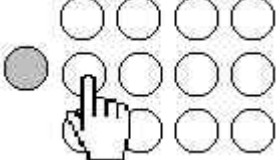



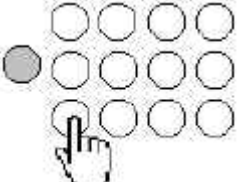

	<p>(1) Under normal mode press the  key</p>
	<p>(2) The display now is showing the high limit</p> <p>PS: ▶ point to Hi (without  showing)</p>
	<p>(3) Press  if you want to enable Hi & Lo checking function.</p>
	<p>(4) Press  if you want to disable the Hi & Lo checking function.</p>

Execute step(1)(2)(3) to enable Hi/Lo checking Function (Now light tower is available)
 Execute step(1)(2)(4) to disable Hi/Lo checking Function

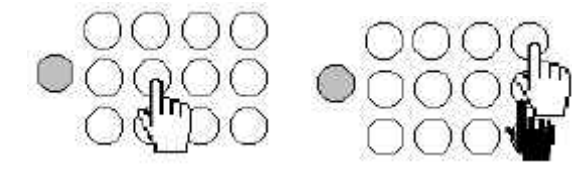



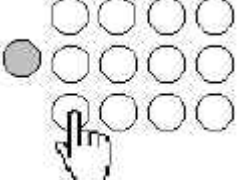

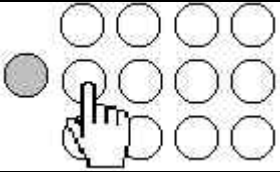

【 Set The High Limit Of The Auto-Tare 】

	<p>(1) Under normal mode press the  key</p>
	<p>(2) The display now is showing the high limit for Auto-Tare (if  isn't showing, press  to make it appear)</p>
	<p>(3) Press  to move rightward (4) You also can press  to plus 1 or  to minus 1</p>
	<p>(5) For example, you change to 0.100kg</p>
	<p>(6) Press  key again and the setting 0.100kg is completed</p>

【Set The Low Limit Of The Auto-Tare】

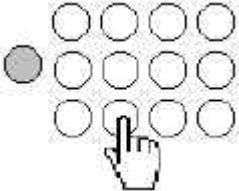
	<p>(1) Under normal mode press the  key</p>
	<p>(3) The display now is showing the high limit for Auto-Tare (if  isn't showing, press  to make it appear)</p>
	<p>(3) Press  to move rightward (4) You also can press  to plus 1 or  to minus 1</p>
	<p>(5) For example, you change to 0.098kg</p>
	<p>(6) Press  key again and the setting 0.098kg is completed</p>

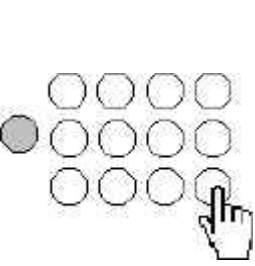









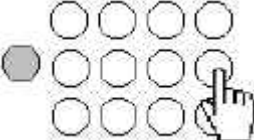

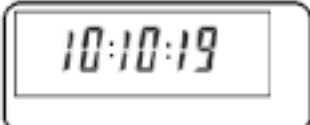

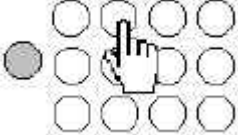

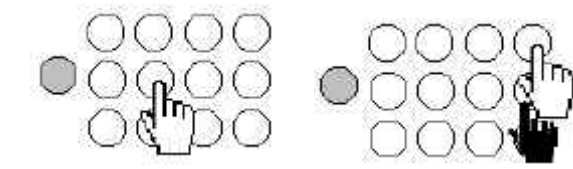

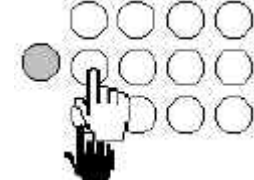

【 Enable / Disable The Auto-Tare Checking Function 】

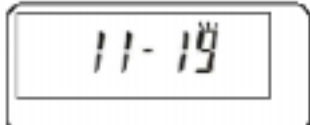
	<p>(1) Under normal mode press the  key</p>
	<p>(4) The display now is showing the high limit for Auto-Tare</p> <p>(if  isn't showing, press  to make it appear)</p>
	<p>(3) Press  if you want to enable the Auto-Tare function.</p>
	<p>(4) Press  if you want to disable the Auto-Tare function.</p>

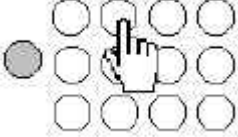
Execute step(1)(2)(3) to enable Auto-Tare Function

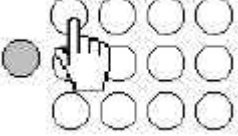
Execute step(1)(2)(4) to disable Auto-Tare Function

【 Show / Readjust The Time 】

	<p>(1) Under normal weighing mode press , then you see the displays show as below.</p>
	<p>(2) You can see now what time it is running. Note: you can press  or  to year and date</p>
	<p>(3) Press  to enter into readjusting mode.</p>
	<p>(4) Go into readjusting mode. PS : One of the digit is being blinking</p>
	<p>(5) Press  to move rightward (6) You also can press  to plus 1 or  to minus 1</p>
	<p>(7) If you want to change the month or year, press  or  to go to date or year display.</p>
	<p>(8) For example, you enter the date display.</p>
	<p>(9) For example, you enter the year display.</p>
	<p>(10) After all setting is finished, press  to renew the date/time and return the showing date/time mode.</p>
	<p>(11) Press  to return normal weighing mode Note: before press , you can press  or  to see the month or year.</p>

Note

This scale is not installed with RTC so the time setting won't be memorized after switch off. Please set correct time whenever the scale is switched-on. (unless the scale is using RS-232 with RTC, then there is no such problem, please contact your supplier for RS-232 with RTC)



【 Data Protection 1 】

	Unit weight	Hi/LO setting	Serial No/Acc setting
Save 990 to MaxAcc	unlock	unlock	unlock
Save 991 to MaxAcc	lock	unlock	unlock
Save 992 to MaxAcc	unlock	lock	unlock
Save 993 to MaxAcc	lock	lock	unlock
Save 994 to MaxAcc	unlock	unlock	lock
Save 995 to MaxAcc	lock	unlock	lock
Save 996 to MaxAcc	unlock	lock	lock
Save 997 to MaxAcc	lock	lock	lock







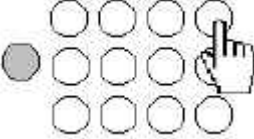

Note:

- (1) The procedure to Save 99X to MaxAcc is the same as Set the max. amount of accumulations
- (2) It seems that you save 99x to MaxAcc, but it is just a virtual action for protection decode, and MaxAcc still keep it's original data.

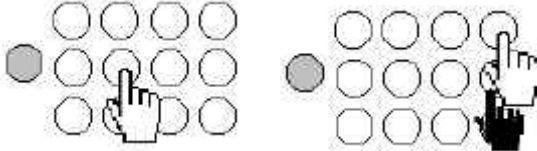





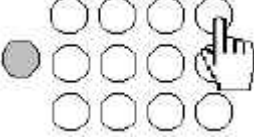

■ Lock Description

Unit weight lock	<p>The advantage of the unit weight lock, is to prevent anybody to alter/-modify the unit weight, without access to the unlock code.</p> <p>(1) Under this lock situation, the PCS and % will calculate by some condition all the times.</p>
Hi/LO setting lock	<p>The advantage of the Hi/Lo setting lock is to prevent anybody to alter /-modify the Hi/Lo setting without access to the unlock code.</p> <p>You can press ,  key to call up the Hi/Lo setting, but it becomes read-only data and you can't modify the data.</p>
Serial No/Acc setting lock	<p>Function is as following</p> <p>(1) To prevent any change of serial No, maximum serial No, and serial No mode.</p> <p>(2) To prevent any change of maximum Accumulation setting and accumulation mode.</p> <p>The advantage is to make sure that when you are doing serial No increase or accumulation is under control. For example, you set accumulation mode to , then it couldn't be change to manual ,stable or other, that make sure that every time the scale do Accumulation is in weight spec.</p>

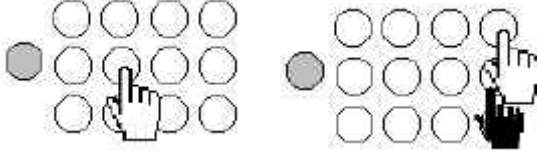



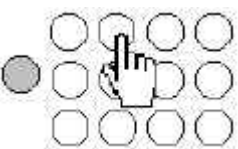





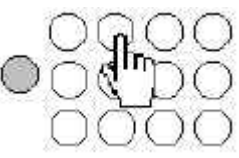

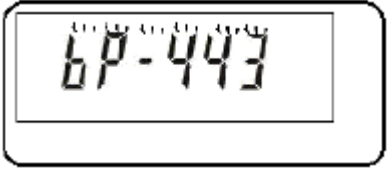
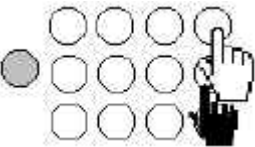
■ How To Lock

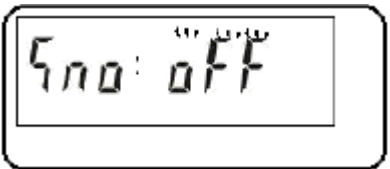
	<p>(1) Under normal weighing mode and when the pan is empty then keep pressing  for 3 second until the following display appears</p>
	<p>(2) The max. amount is now blinking.</p>
	<p>(3) Press  to move rightward (4) You also can press   to increase 1 or decrease 1</p>
	<p>(5) For example change to 991 to lock the PCS and % condition Note: You can use from 991 to 997 to do different locks.</p>
	<p>(6) Press  to save the change and return to normal weighing mode.</p>

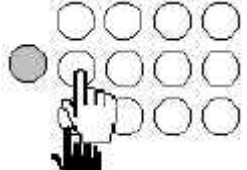
■ How To Unlock The All Settings

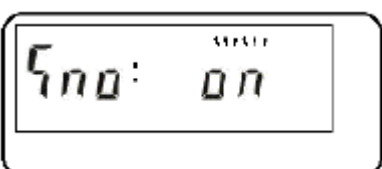
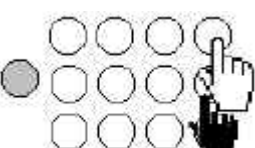
	<p>(1) Under normal weighing mode and when the pan is empty then keep pressing  for 3 second until the following display appears</p>
	<p>(2) The max. amount is now blinking.</p>
	<p>(3) Press  to move rightward (4) You also can press   to increase 1 or decrease 1</p>
	<p>(5) Change to 990 to unlock all setting</p>
	<p>(6) Press  to save the change and return to normal weighing mode.</p>

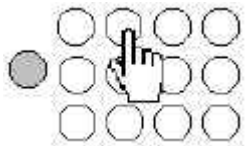
【 Parameter Settings 】



	<p>(1) Under normal weighing mode keep pressing  for about three seconds.</p>
	<p>(2) You are now being in parameter settings mode.</p>
	<p>(3) Press  or  to switch between the parameters.</p>
	<p>(4) Repeat step (3) to that parameter that you're going to change. For example like  appear</p>
	<p>(5) Press  or  to turn on as following display</p>
	
	<p>(6) Press  or  to save and go to next parameter setting</p>
	<p>(7) Or you can skip step(6) ,and directly Press  to save the setting and return to normal weighing mode.</p>

【 Parameters Description 】

- **POW:OFF power (default : off)**
 (item : off/ 10/20/30/40/50/60/70/80/90min)
 * if setting=10, when there is no object on scale for ten min, it will shut off automatically.
- **BFL:Auto : backlight (default : auto)**
off : always off **on** : always on
Auto : turn on when the weight is greater than 20e
- **Sno:OFF Sno (default : off)**
off : never display **on** : **Serial No** will display when measuring value is zero

* The scale will saving the latest serial number when it be turn off normally.
 As it is shut off improperly, the memory won't be saved, like plug off the power cable.
- **BEP:OFF beep sound (default : in)**
in : when check is OK **out** : when check is Hi / Lo (**in,out** using scale's buzzer)
E in : when check is OK **E out** : when check is Hi / Lo (**E-in,E-out** using light tower's buzzer)
- **normal/SH-24/EZ-2P/BP-343 Printer (default : normal)**
 item : normal / SH-24/EZ-2P / BP-443D)
 There is only a difference between normal and SH-24. SH-24 has the ability to print out some Chinese.
- **19200/9600/4800/2400 BaudRate (default : 9600)**
 (item : 19200/9600/4800/2400)
- **EB /oB /nB /E7 /o7 /n7 / data Format (default : n81)**
 (item : n81/o81/e81/n71/o71/e71)

【 The Rule For Using The Keypad 】

1. Press  and return to the normal weighing mode in any situations.
2. Press  to clear the input number to 0.
3. There will be short beep whenever you press any key; a long beep sound indicates successfully setting and three beep sounds indicate an error.

【Connector】

Scale To Printer

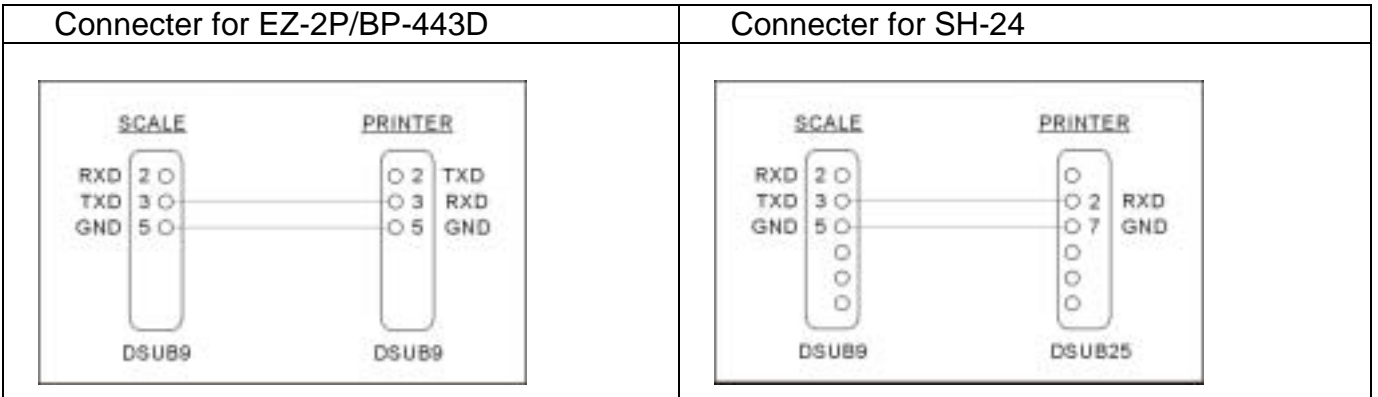

Scale To PC

When you want a scale to transmit data to PC continuously.

- (1) Using a cable as following to connect Scale and PC
- (2) Set printer mode as continue
- (3) Scale data will be sent to PC continuously. (of course, you must have the receiving software on the PC)

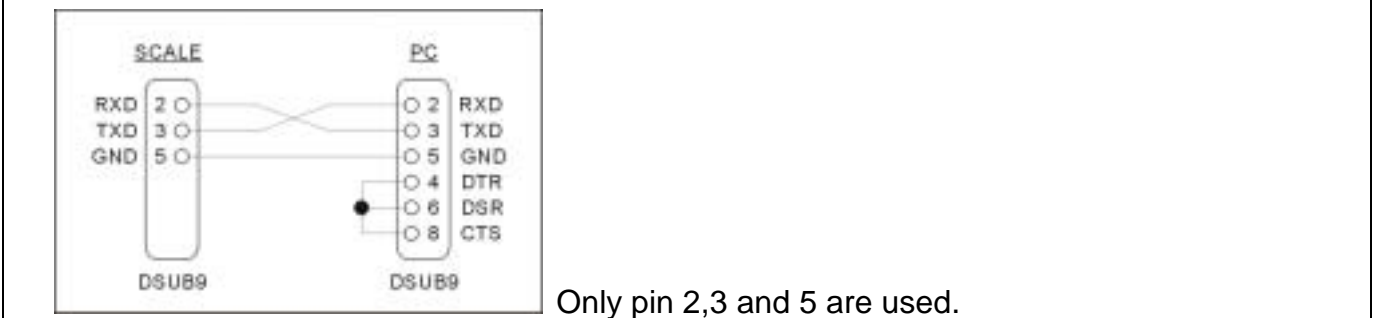

【Data Protocol】

- **Output Data when Print Mode set as Continue**

(header1: ST=STABLE US=UNSTABLE)
 (header2: NT=NET GS=GROSS)

For example : ST /NT + 12.350 kg

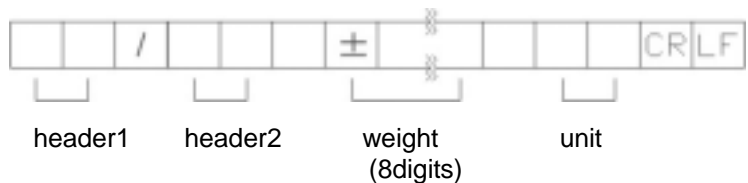

- **Input commands**

“T” = perform TARE function

“Z” = perform ZERO function

【 Applications 】

■ Quality Checking According To Weight.

For example a batch of PDA outer casing box is weighing 79~82g

- (1) Set the Hi limit at 0.082 kg, Lo limit at 0.079 kg
- (2) Enable the HI/LO checking function
- (3) Start weighing now and carry out the HI/LO (weights) checking function.

Note : You may set the beeping sounds according to your needs. Please refer to the parameter of Beeping Sounds.

■ Control Check On Each Packing According To Weights.

For example a manufacturer of DVD player, the standard packing weights of one DVD player is 1.731kg inclusive of :

DVD player	1.200	kg
Adaptor	0.148	kg
User Manual	0.090	kg
Packing Material	0.293	kg

Total Weights	1.731	kg

Assume that a standard error of ± 30 g is allowed for every packing . So ,

- (1) Set the HI limit for weight at 1.761 kg, LO limit at 1.701 kg
- (2) Enable the HI/LO checking function
- (3) Start weighing now and carry out the HI/LO (weights) checking function.

Note : (1) You may set the beeping sounds according to your needs. Please refer to the parameter of Beeping Sounds.

- (2) Sometime the scale is unable to read the shortage of item if for example :-
if there are 2 adaptors in this packing which are now $0.148\text{kg} \times 2 = 0.296\text{kg}$
and there are shortage of 0.150g in packing material which at the end still made up to the total of 1.733kg .

■ Auto Tare On The Weight Of Boxes , Basket Or Container

If a fruits monger want to pack his fruits in a standard packing basket . He wish that the weight of the basket will be auto tare-off when the basket is place on the weighing pan, and when he remove the basket , the scale will cancel off the tare value and return to zero.

Assumed that the weight of the basket is 0.450 ~0.480kg

- (1) Under the HI/LO checking for TARE , set the HI limit 0.480g, Lo limit at 0.450g.
- (2) Enable the HI/LO checking function
- (3) Place the basket on the pan , you will hear a beep sound. The display show like  indicate that the weight of basket has been tare .
- (4) start packing the fruits .
- (5) after complete the packing , remove the whole basket, when the scale reaches the zero point, you will hear a beep sound and TARE will be canceled.

■ Control The Total Production Volume According To Serial Number

- (1) enter the parameter setting and turn on the serial number
- (2) set the mode of serial number according to weight (within the HI/LO limit), serial number will add 1.
- (3) start weighing, when the weight is stable and is within the HI/LO limit , the number will add 1.

■ With This Function , The Total Production Volume And Weight Of Packing Can Be Checked According To Serial Number .

■ Control The Production According To The Maximum Serial Number.

Assumed that a production line need to do the packing for every 100 standard items produced :

- (1) turn on the serial number
- (2) set the mode of serial number according to weight (within the HI/LO limit), serial number will add 1.
- (3) set the maximum serial number to be 100
- (4) start weighing, when the weight is stable and is within the HI/LO limit , the number will add 1.
- (5) when the serial number reach 100 , the unit weight display will show a blinking סתירה and beeping sounds , meaning that have reached 100 standard items and you can do the packing now.
- (6) the serial number will return and start from 1 again , after the 100th serial number

■ Difference Printing Format For Difference Products

This scale is well equipped with 100 difference printing formats according to your needs . Please refer to 【label & sample of the printing formats】 .

■ Using The Tower Light To Indicate A Defect Or Shortage In Production

The examples of production control mentioned above can be more effective by Using a tower light connecting to the scale. The advantage of the tower light is to overcome the noisiness in the production line and enable the users to check the production through the signals of the tower light .

■ Please Contact Your Nearest Dealer Or Sales Person If You Have Others Special Requirements Related To The Scale.

【FAQ】



■ Why can't the printer print out, when I connect to the scale?

1. Make sure the rs232 transfer format setting is same as your printer.like
9600,n81
2. If EZ-2P or BP-443D are being used, they should have download the printer format before.

■ Why does the Hi & Lo checking not work?

1. Make sure you have enabled the function.
2. if the value of Lo is greater than Hi, it wont work properly

■ How do check if my printer compatible to the scale ?

1. Make sure the rs232 transfer format setinge is same as your printer.like
9600,n81
2. When you weight and  sign appeared, press ,key to print . If the printer able to print meaning that this printer can replace the SH-24 printer .

■ Why are there no sounds in the Hi & Lo checking function?

Make sure the parameter of beep is set correctly

■ Why do I have to reset the time every time I turn on the scale?

The scale needs an optional RTC.















【 LCD Characters 】

0	1	2	3	4	5	6	7	8	9
0	1	2	3	4	5	6	7	8	9

A	B	C	D	E	F	G	H	I	J	K	L	M
A	b	C	d	E	F	G	H	i	J	K	L	M









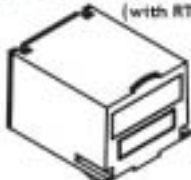

N	O	P	Q	R	S	T	U	V	W	X	Y	Z
n	o	P	q	r	S	t	U	v	w	x	y	Z

【 Error Messages 】









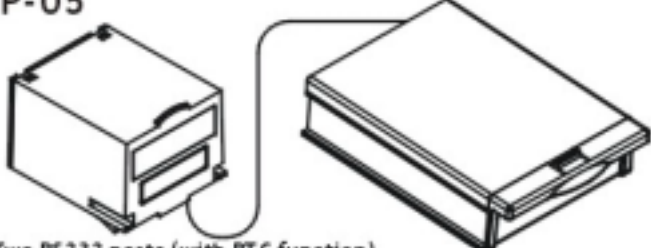

Error Message	Reasons	Solutions
	The CPU unable to read the EEPROM	Return To The Manufacturer
	Unable to read the 3 points calibration range	Do the 3 points calibration
	Zero Point is Too High	Make sure the pan is empty when turn on the scale or perform the 3 points calibration.
	Zero Points is Too low	Make sure the pan is on the scale or perform the 3 points calibration.
	Unstable Zero Point	(1)Make sure there is no winds or vibration . (2)Change the stability /vibration parameter accordingly.
	Battery for RTC is too weak	Replace a new battery or press  to abort.
	Overload (The weights on the pan is more than +9e of the max. capacity)	Take away the overloaded objects.
	Unable to accumulate due to contradiction in different unit . You cannot accumulate this two together .	Press  key twice to clear the all the accumulation or press  key to return to normal weighing mode .
	The last accumulation is more than the preset accumulation allowed .	Press  key twice to clear the all the accumulation or press  key to return to normal weighing mode .

【 Option 】

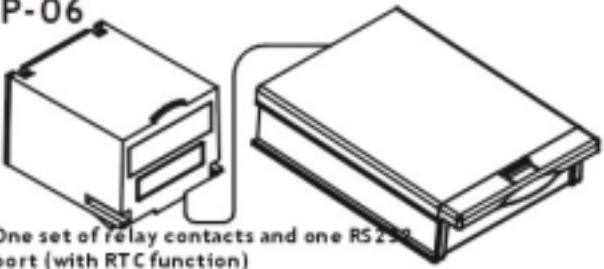

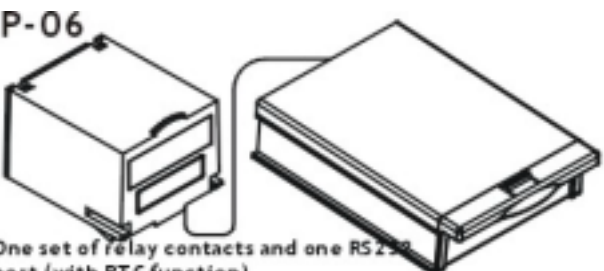
■ Only One Optional Device Being Used

	Option	Application	Remark
AP1	<p>OP-03 One RS232 port (with RTC function)</p> 	<p>+</p>  <p>BP-443D</p>	<p>Can print out Bar Code</p> 
AP2	<p>OP-03 One RS232 port (with RTC function)</p> 	<p>+</p>  <p>SH-24</p>	<p>Can print out accumulation data</p> 
AP3	<p>OP-03 One RS232 port (with RTC function)</p> 	<p>+</p>  <p>LED Display</p>	<p>→ Only the weighing data can be shown on LED Display</p>
AP4	<p>OP-01 One set of relay contacts</p> 	<p>+</p>  <p>LED Light Tower</p>	<p>→ Three lights of light tower to indicate three different situation, easy to see, besides it's buzzer is loud enough even in a noisy place.</p>

■ Two Optional Devices Being Used

	OPTION	REMARK
AP5	<p>OP-05</p>  <p>Two RS232 ports (with RTC function)</p>	 <p>PC</p> <p>or</p>  <p>BP-443D</p>  <p>LED Display</p>
AP6	<p>OP-06</p>  <p>One set of relay contacts and one RS232 port (with RTC function)</p>	 <p>BP-443D</p>  <p>LED Light Tower</p>
AP7	<p>OP-06</p>  <p>One set of relay contacts and one RS232 port (with RTC function)</p>	 <p>LED Light Tower</p> <p>or</p>  <p>PC</p>  <p>LED Display</p>

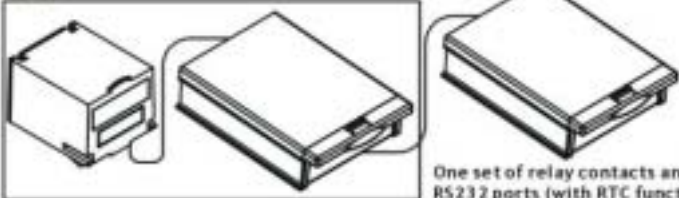
■ Three Optional Devices Being Used

	OPTION	REMARK
AP8		 <p>BP-443D</p>
	<p>OP-07</p>  <p>One set of relay contacts and two RS232 ports (with RTC function)</p>	 <p>LED Display</p>
		 <p>LED Light Tower</p>

【 Relay Module Diagram 】

■ Relay Output :

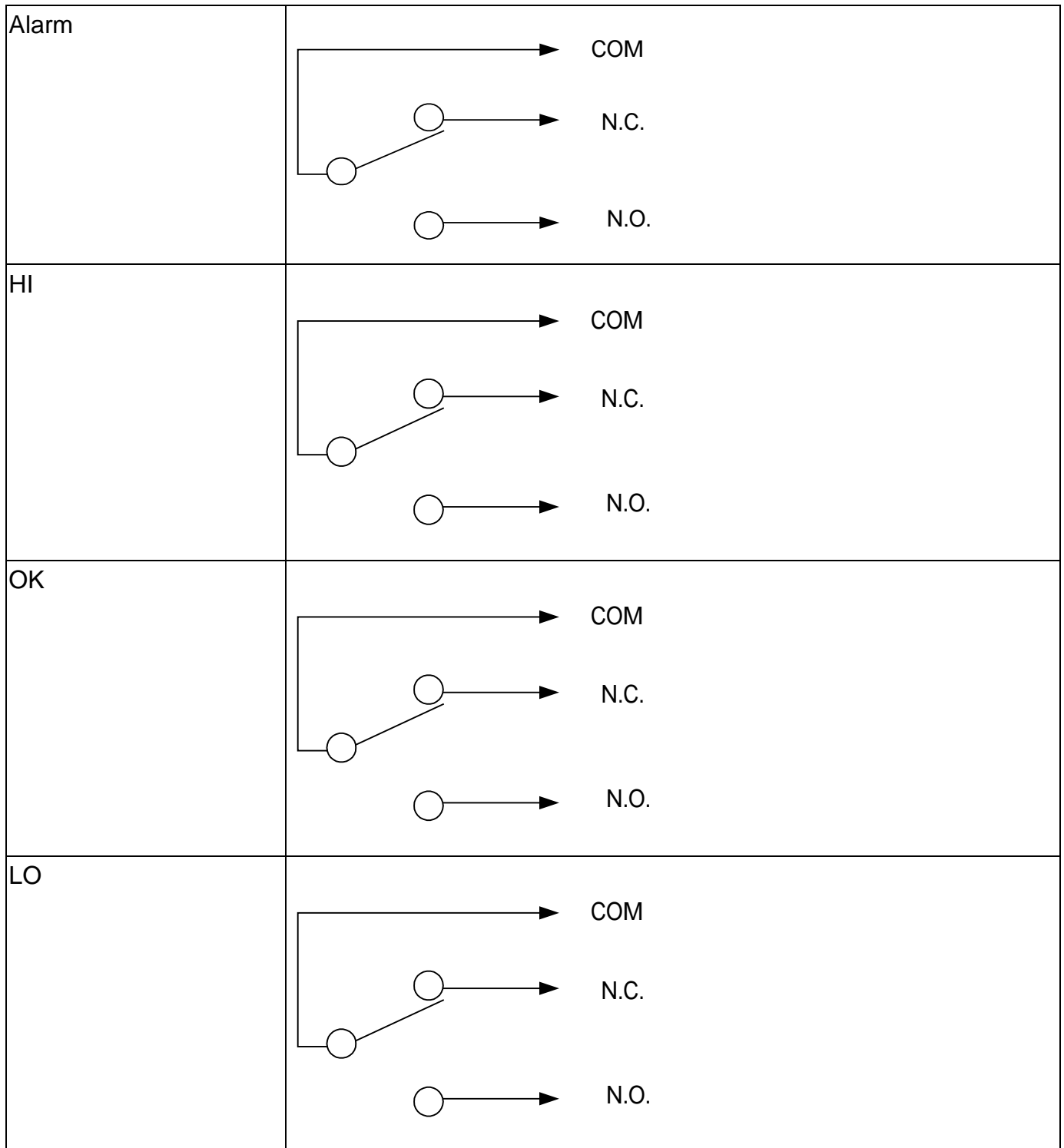

■ Relay Contact Spec

1A/24VDC , 0.5A/125VAC , 0.25A/250VDC